

VarioTel 2
No. 28 245.0001, 28 246.0001,
28 247.0001



CE 0682

GB Operating instructions
Please take care of the operating instructions!

NRG Automation Ltd.
Foundry Lane –
Halebank
Widnes,
Cheshire WA8 8TZ
sales@
nrgautomation.co.uk
www.elero.com

**elero Motors & Controls
Pvt. Ltd.**
507, DDA Building II
District Centre Janak Puri
IND-New Delhi – 110 058
Tel. (91)-11-417 24 219
Fax (91)-11-417 24 338
e-mail: india@elero.com

elero Singapore Pte. Ltd.
No. 2,
Ang Mo Kio Street 64
#03-00 Ang Mo Kio
Industrial Park 3
SGP-Singapore 569084
Tel. (65) 68 99 90 62
Fax (65) 68 99 90 64
e-mail:
info@elero.com.sg

elero GmbH
Antriebstechnik
Linsenhofer Str. 59–63
D-72660 Beuren
info@elero.de
www.elero.com

Device explanation	GB- 2
Safety instructions/exclusion of liability	GB- 3
Scope of supply/ intended use	GB- 5
Bidirectional radio system/unidirectional radio system	GB- 6
Mounting of the wall bracket	GB- 8
Explanation of functions	GB- 9
Status LED	GB- 9
Group control unit	GB- 9
Select button	GB-10
Programming the transmitter	GB- 11
Programming the transmitter/channel	GB- 11
Programming further transmitters	GB-12
Approach limit positions of roller shutter/awning/ venetian blind	GB-13
Intermediate positions for roller shutters/awnings/ venetian blinds	GB-14
Program intermediate position	GB-14
Program ventilation/tilting position	GB-15
Approach intermediate position	GB-15
Approach ventilation/tilting position	GB-15
Position deletion	GB-16
Delete ventilation/tilting position	GB-16
Deletion of transmitter	GB-17
Deletion of individual transmitters	GB-17
Deletion of all transmitters	GB-17
Technical data	GB-17
Battery replacement	GB-18
Cleaning	GB-18
Disposal	GB-18
Notes on troubleshooting	GB-19
Notes on repair	GB-19
Repair address	GB-19

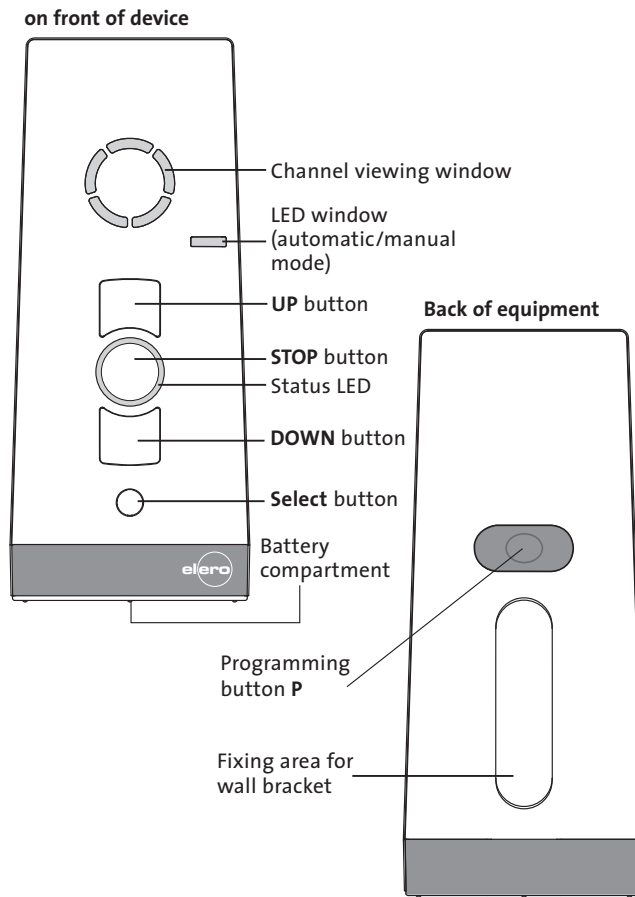

	<p>STOP!</p> <p>Observance of the operating instructions is the prerequisite for disturbance-free operation and fulfilment of any claims related to defects.</p> <ul style="list-style-type: none"> • Therefore, first read the operating instructions before you use the device! • Ensure that the operating instructions are available to the user in legible form. • The operator must ensure that the basic safety measures are observed and fulfilled. • The operator must have completely read and understood the operating instructions. • The following safety and installation instructions solely refer to the transmitter and not the accessories and drive.
--	---

Exclusion of liability:

It is essential to observe these operating instructions for use if the VarioTel 2 hand-held transmitter is to be used safely and if the various product characteristics and performance features are to be achieved.

elero GmbH assumes no liability for personal injuries, property damages and financial losses that arise from non-observance of the operating instructions.

Liability for material defects is excluded in such cases.

	<p>CAUTION!</p> <p>Observe the following safety instructions. Failure to observe them can lead to bodily injuries!</p> <p>General</p> <ul style="list-style-type: none"> • Never install or commission devices which are damaged. • Only use unmodified original elero electrical parts. • If the device is opened without permission or used in an improper manner, or if it is incorrectly installed or operated, there is a risk of damage to persons and property. • The device contains small parts which can be swallowed. <p>Transport</p> <ul style="list-style-type: none"> • If the transmitter arrives in a damaged condition despite proper packaging, then it must not be commissioned. Immediately report the damage to the transport company. <p>Installation</p> <ul style="list-style-type: none"> • Note any country-specific conditions when installing the device. • The device may only be used by persons who have read and understood the operating instructions. <p>Operation</p> <ul style="list-style-type: none"> • Use only in dry rooms. • If one or more transmitters are used for controlling the system, its operating range must stay visible during operation. • Keep children away from the control units. • Replace battery only with identical type (LR06;AA). • Dispose of used batteries properly (collection point).
---	---

Manufacturing note

All the ProLine 2 transmitters are subject to 100% testing by elero GmbH before delivery.

The ProLine 2 transmitters are made as per the following guidelines:

- EN 300 220 (electromagnetic compatibility of radio systems)
- ETS 300 683 (Specific conditions for short range radio devices)
- CE mark

Scope of supply

VarioTel 2 (batteries (2 x LR 06; AA) supplied with device)
Wall bracket
2 dowels
2 screws

Intended use

The VarioTel 2 is a multi-channel transmitter. Each channel can be used unidirectionally (compatible with the existing ProLine programme) or bidirectionally. The hand-held transmitter may only be used for controlling roller shutters, venetian blinds and sun protection systems that are fitted with elero radio receivers.

Other use, or use which goes beyond this use is not considered to be use for intended purpose.

elero GmbH shall not be liable for:

- Other uses than those described above
- Changes to the device
- Improper use

Please see the technical data contained in these operating instructions.

What does bidirectional radio system mean?

A bidirectional radio system is one that carries out the reliable transmission of radio signals to a radio receiver and provides feedback from the radio receiver to the transmitter.

The radio signal can be sent directly to the target receiver. If this is not possible then the radio signal is forwarded via other participants until the signal reaches the target receiver.

The target receiver carries out the command and sends a confirmation back to the transmitter.
The status LED lights up briefly for confirmation.

What is a unidirectional radio system?

A unidirectional radio system provides reliable transmission of radio signals to a radio receiver.

However, the radio receiver cannot send back a reply to the transmitter, unlike in a bidirectional radio system.
It is also not possible to pass on the radio signal from one radio receiver to another.



CAUTION!

Observe the following safety instructions for radio operation!

Only use radio systems if they are approved and can be operated without interference.

- Please note that radio systems must **not** be operated in areas with an increased risk of interference (e.g. hospitals, airports, ...).
- The remote control is only approved for devices and systems for which any malfunction of the transmitter or receiver would not result in a risk for persons, animals or property, or if such a risk is covered by other safety equipment.
- The operator has no protection whatsoever from interferences by other radio emitters and local terminals (e.g. also from radio systems), that are normally used on the same frequency range.
- The range of the radio signal is limited by the government and the built environment.



NOTICE!

The wall bracket has to be fixed so that the drill holes don't touch any electrical lines.

Check this before installation.

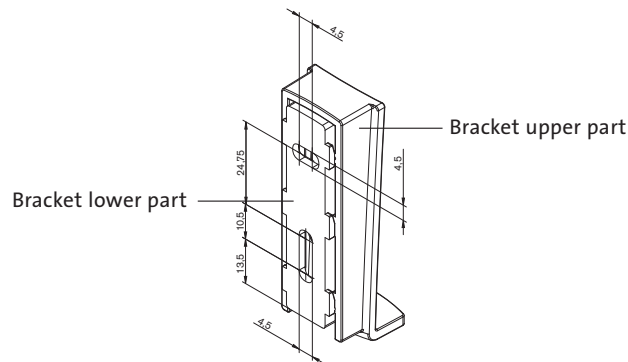

Mounting of the wall bracket

1. Use the drilling template on the inside of the packing box.
2. Remove the cover from the box.
3. Fix the drilling template to the wall.
4. Drill the holes in the wall.
5. Remove the drilling template.
6. Push the bracket upper and lower parts to separate them.
7. Fix the bracket lower part onto the wall using the screws and dowels provided.
8. Push the bracket upper part from above onto the bracket lower part until it is locked into place.

Status LED

A radio signal is displayed by the illumination of the Status LED (LED ring around the STOP button).

The status LED can display three different colours:

- Orange: Transmit signal is being sent (bidirectional radio operation)
- Green: Transmit signal is being sent (unidirectional radio operation)
Positive reply from the transmitted signal (bidirectional radio operation)
- Red: No answer from receiver (bidirectional radio operation)

The transmitting power or the radio range will be reduced through the reduction in the performance of the battery.

If the status LED no longer illuminates upon pressing the button, the batteries have to be replaced.

Please see these instructions for changing the battery.
(→ see battery replacement)

Group control unit

A group is understood to mean the control of several receivers at the same time. The selected group is controlled by a travel command.

With VarioTel 2 you can use all five radio channels to control a group.

The central channel (all five channel viewing windows light up simultaneously) controls all five radio channels at the same time.

Select button (channel selection button, AUTO switching button)

Up to 5 channels can be selected by pressing the **Select** button briefly.

The individual channels are displayed by illumination of the associated channel viewing windows.

An additional channel is reserved for the central command. This is allocated automatically. All five channel viewing windows illuminate to indicate the central command.

Pressing the **Select** button briefly allows the current status of the programmed receiver and the channel of the hand-held transmitter to be queried.

Longer pressing (approx. 1 sec.) of the **Select** button switches off the automatic mode. The LED window lights up red.

→ The receiver now only executes manual travel commands.

Longer pressing (approx. 1 sec.) of the **Select** button again switches on the automatic mode. The LED window lights up green.

→ The receiver now executes automatic and manual travel commands.

Programming the transmitter

	PREREQUISITE!
	The receiver must be installed. Note that the radio range to the receiver is limited during programming. Position yourself in front of the shutter/blind for programming.

1. With electrical, previously installed receivers, turn the safety fuse off and after a few seconds on again.
The receiver is now in programming mode for about 5 minutes.
2. Press the programming button **P** on the back of the device **briefly** (approx 1 sec).
The shutter/blind moves up and down automatically after approx. 2 minutes to show that the receiver is in programming mode.
3. Press the **UP** button **immediately** after the start of upward travel (max. 1 second).
The status LED lights up briefly.
The blind will stop – start moving again – stop and then move in the DOWN direction.
4. Press the **DOWN** button **immediately** after the start of downward travel (max. 1 second).
The status LED lights up briefly.
The blind/shutter will stop.
The VarioTel 2 is now programmed.

	NOTICE!
	If the blind does not stop, the programming process must be repeated.

Programming additional transmitters

	NOTICE!
	If several receivers are connected to the same feed line, then all are simultaneously ready to program. The blinds start a “random” brief up/down travel. The longer you wait with the programming the greater will be the offset. You can stop the brief up/down travel by briefly pressing the STOP button on a transmitter which has already been programmed. The programming procedure is interrupted. The transmitter assignment can now be made without having to disconnect individual receivers. If the blind travels in the wrong direction, delete the transmitter and reprogram it. (→ see Deletion of transmitter)

To programme additional transmitters in one receiver, please proceed as follows:

1. Press the **UP**, **DOWN** and the programming button **P** (back of device) **simultaneously** (for 3 sec.) on a transmitter, which has already been programmed to the receiver. The status LED lights up briefly.
Push the programming button **P** (on back of device) on the new transmitter to be programmed until the status LED lights up briefly.
2. Press the **UP** button **immediately** after the start of upward travel (max. 1 second).
The status LED lights up briefly. The blind will stop – start moving again – stop and then move in the DOWN direction.
3. Press the **DOWN** button **immediately** after the start of downward travel (max. 1 second).
The status LED lights up briefly. The blind will stop.
The transmitter or the transmitter channel has been programmed.

!	PREREQUISITE!
	The transmitter/transmitter channel has been programmed. The end positions of the drive have been set.

Approach lower end position (roller shutter/awning)

Press the **DOWN** button briefly.
The blind approaches the lower end position/the awning moves out.

Approach lower end position (venetian blind)



Press the **DOWN** button until the status LED lights up briefly.
The blind approaches the lower end position.
Press the **DOWN** button briefly (jogging mode); the blind moves a short distance and stops again.

Approach upper end position (roller shutter/awning)

Press the **UP** button briefly.
The blind approaches the upper end position/the awning retracts.

Approach upper end position (venetian blind)

Press the **UP** button until the status LED lights up briefly.
The blind approaches the upper end position.
Press the **UP** button briefly (jogging mode); the blind moves a short distance and stops again.

	Roller shutters	Awning	Venetian blind
			
Pos ▾	Intermediate position	Intermediate position	Intermediate position
Pos △	Ventilation position	–	Tilting position

Program intermediate position

!	PREREQUISITE!
	The transmitter/transmitter channel has been programmed. The end positions of the drive have been set. The blind/shutter is at its upper end position.

1. Move the blind as far as necessary in the **UP** direction until the ventilation gaps open or the slats are inverted.
Hold down the **UP** button until the desired position is reached.
2. **In addition** press the **STOP** button.
The blind/shutter will stop. The status LED lights up briefly.
The intermediate position/ventilation position is now programmed.

Program ventilation/tilting position

	PREREQUISITE!
	The transmitter/transmitter channel has been programmed. The end positions of the drive have been set. The blind/shutter is at its lower end position.

1. Move the blind as far as necessary in the UP direction until the ventilation gaps open or the slats are inverted.
Hold down the **UP** button until the desired position is reached.
2. **In addition** press the **STOP** button.
The blind/shutter will stop. The status LED lights up briefly.
The intermediate position/ventilation position is now programmed.

Approach intermediate position

	PREREQUISITE!
	The transmitter/transmitter channel has been programmed.

1. Press the **DOWN** button briefly **twice**. The status LED lights up briefly.
2. The blind travels to the stored intermediate position.
In the case of venetian blinds, after reaching the intermediate position, the slats turn automatically.
If no intermediate position has been programmed the blind/shutter travels to the lower end position.

Approach ventilation/tilting position

	PREREQUISITE!
	The transmitter/transmitter channel has been programmed.

1. Press the **UP** button briefly **twice**. The status LED lights up briefly.
2. The blind/shutter travels to the stored ventilation/tilting position.
If no ventilation/tilting position has been programmed the blind/shutter travels to the upper end position.

Delete intermediate position

1. Press the **STOP** button and **also** the **DOWN** button.
2. Hold down this button combination for approx. 3 sec.
The status LED lights up briefly.

Delete ventilation/tilting position

1. Press the **STOP** button and **also** the **UP** button.
2. Hold down this button combination for approx. 3 sec.
The status LED lights up briefly.

Delete transmitter/channel

1. Press the **STOP** button and **also** the programming button **P** (back of unit).
2. Hold down this button combination for approx. 6 seconds until the status LED lights up briefly orange and then red.
In the unidirectional radio operation the status LED lights up green briefly twice and then orange during the 6 seconds.

Deletion of all transmitters

1. Press the **STOP** button and **also**:
 - Programming button **P** (on back of device)
 - **UP** button
 - **DOWN** button
2. Hold down this button combination for approx. 6 sec.
The status LED lights up briefly twice.
In the unidirectional radio operation the status LED lights up green briefly twice and then orange during the 6 seconds.

Technical data

Operating voltage	3 V DC
Battery type	2 x LR 06 (AA cells)
Protection class	IP 20
Permitted ambient temperature	0 to +50 °C
Radio frequency	868 MHz frequency band
Dimensions in mm	L 120 x W 51 x H 26

Battery replacement**NOTICE!**

- Replace batteries only with identical type (2 x LR 06; AA cells).
- Dispose of used batteries properly (collection point).

1. Unscrew the hand-held transmitter using a suitable screwdriver on the underside of the device and remove the cover.
2. Remove the batteries.
3. Insert the new batteries (2 x LR 06; AA cells) **correctly** in the transmitter.
4. Place the cover on the housing again and screw on tightly with the screwdriver.

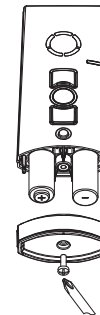
**Cleaning**

Clean the device with a damp cloth.

Don't use any cleaning agents. This may attack the plastic.

Disposal

Please observe the current national regulations. Dispose of according to the condition and existing regulations.

e.g. as:

- Electrical scrap (PCB)
- Plastic (Housing parts)
- Batteries

Notes on troubleshooting

Fault	Cause	Remedy
The drive does not run, the status LED does not light up.	<ol style="list-style-type: none"> 1. Batteries are low. 2. Batteries are incorrectly installed. 	<ol style="list-style-type: none"> 1. Replace batteries. 2. Insert batteries correctly.
The drive does not run, the status LED lights up red.	<ol style="list-style-type: none"> 1. The receiver is outside the radio range. 2. Receiver out of order or faulty. 	<ol style="list-style-type: none"> 1. Reduce distance to the receiver. 2. Switch on or exchange receiver.
Drive does not run.	Wrong group selected.	Select the right group.
Drive operates in the wrong direction.	Directions are incorrectly allocated.	Delete transmitter and reprogram.

Notes on repair

Please contact us if you are unable to eliminate a problem.
 When contacting our service team, please always state the item description and number from the type plate (back of device).

- Item number
- Item description
- Type of fault
- Accompanying conditions
- Own presumption
- Previously occurring unusual events

Repair address:

elero GmbH
 Antriebstechnik
 Linsenhofer Straße 59–63
 D-72660 Beuren
 Telephone (0 70 25) 13-01
 Fax (0 70 25) 13-212
 www.elero.com

Please visit us on the Internet
 if you require a contact outside
 Germany.